

**DIODI ZENER**

**1.0W DL-41**

Codice Adimpex: **YB520051-L**

ZENER MELF 5% 5.1V 1W DL4733A\*

Serie:DL47

p/n:T/R-1,500 PCS-7"

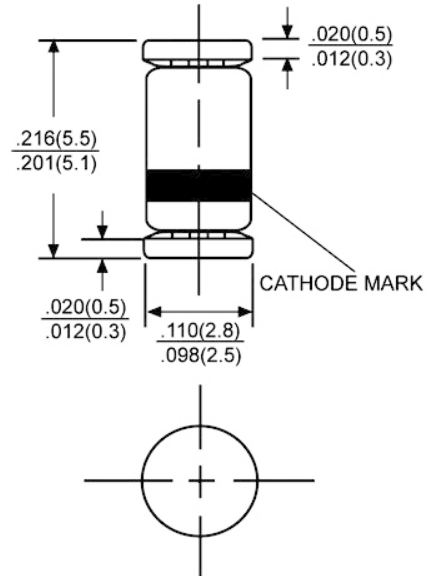

**Codice Adimpex**

**YB520xxx**

**Gamma di valori  $V_Z$**

$3.3 \div 91 V$

	<b>z</b>	<b>x</b>	<b>x</b>
per valori da 3.3V a 9.1V	0	prima cifra significativa	seconda cifra significativa
per valori da 10V a 91V	prima cifra significativa	seconda cifra significativa	0

Come ordinare: