

DIODI ZENER

1.0W DL-41

Codice Adimpex: **YB520033-L**

ZENER MELF 5% 3.3V 1W DL4728A*

Serie:DL47

p/n:T/R-1,500 PCS-7"

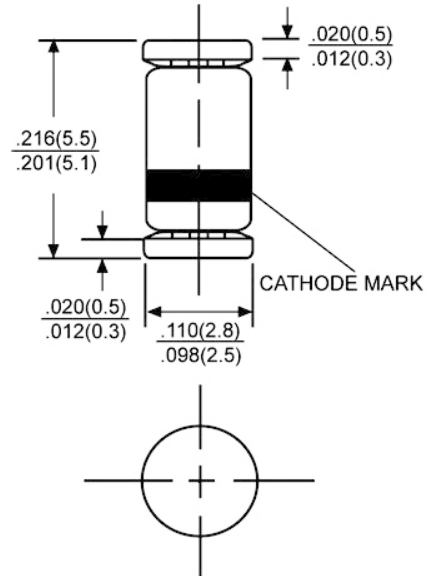

Codice Adimpex

YB520xxx

Gamma di valori V_Z

$3.3 \div 91 V$

	z	x	x
per valori da 3.3V a 9.1V	0	prima cifra significativa	seconda cifra significativa
per valori da 10V a 91V	prima cifra significativa	seconda cifra significativa	0

Come ordinare: