

Accessori

PORTALED METALLICO CONICO PER LED Ø5MM

PORTALED MET.CONICO 5MM

Codice Adimpex: **VD100450-R**

P/N: **12506GH/450**

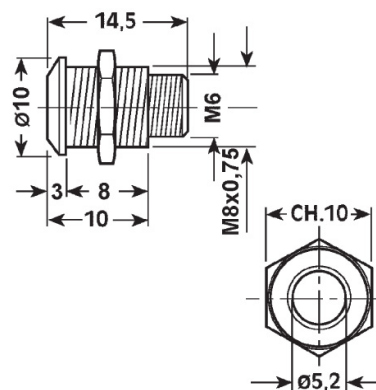

Caratteristiche Tecniche:

Diametro Led (mm):	5
Gamma:	Portaled metallici