

Connettori IDC

SMD MASCHIO DRITTO PASSO 1.27MM 10P IN REEL

IDCmas1.27 SMD 5BH3MSB49-24G05RU-L0 reel/cap

Codice Adimpex: **THS20124-R**

P/N: **5BH3MSB49-24G05RU-L0**

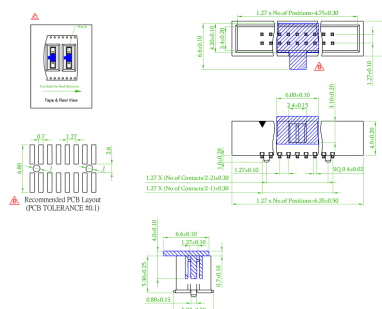
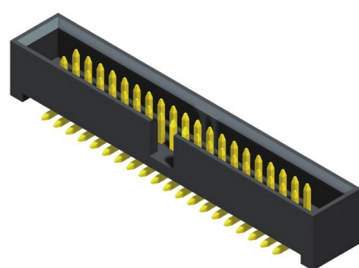

Caratteristiche Tecniche:

Passo:	1.27 mm
Pin totali:	10
Tipologia:	Maschio
Colore:	Nero
Montaggio:	SMD
Orientamento:	Verticale