

Connettore IP68 da pannello con dado per contatti femmina $\phi 1.0\text{mm}$

Codice Adimpex: **PB020008-R**

UTS71210S FM. PANN. DAD. 1.0

Serie:UTS7-S

p/n:UTS71210S

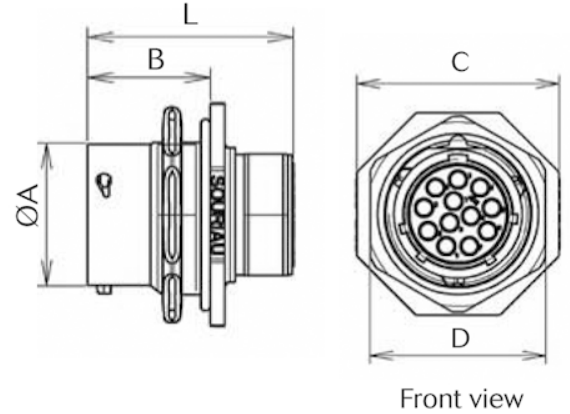

Codice Adimpex	tipo	n. pin	ϕA	B	L	C	D
PB020004	106	6	14.9	19.3	33.9	27.0	22.2
PB020008	1210	10	19.0	19.3	33.9	31.8	27.0
PB020012	1419	19	22.2	19.3	33.9	34.9	30.2

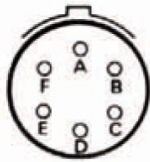

106
6A max.

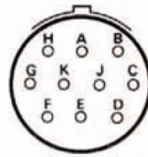

1210
6A max.

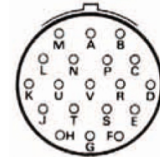

1419
4A max.