

MORSETTIERE MODULARI ESTRAIBILI

Morsettiera maschio orizzontale passo 5.08mm

Codice Adimpex: **MOS02730-R**

MORS.mod CIM-03-9M5 3P/5.08 HO verde

Serie: CIM-9M5

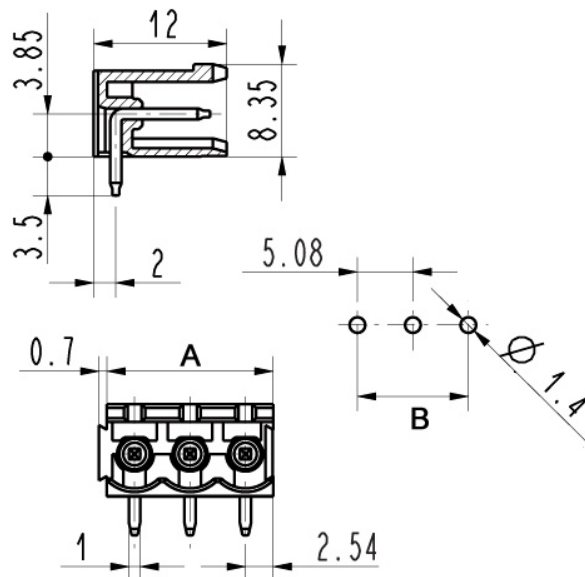

Codice Adimpex	passo	portata	AWG	n. poli	A	B
MOS02720	5.08 mm	16 A	12÷30	2	n x 5.08	(n-1) x 5.08
MOS02730	5.08 mm	16 A	12÷30	3	n x 5.08	(n-1) x 5.08
MOS02740	5.08 mm	16 A	12÷30	4	n x 5.08	(n-1) x 5.08



CARATTERISTICHE

- Contatti: lega di rame
- Trattamento della parte terminale: stagnato
- Corpo: poliammide PA66 UL94V-0 **verde**
- Tensione: 250V
- Resistenza di contatto: < 15 mΩ
- Resistenza di isolamento: >109 Ω a 500V DC
- Temperatura di lavoro: -40°C ÷ 110°C

FEATURES

- *Contacts: copper alloy*
- *Surface of solder tail: tin plated*
- *Body: polyamide PA66 UL94V-0 **green***
- *Voltage: 250V*
- *Contact resistance: < 15mΩ*
- *Insulation resistance: >109 Ω at 500V DC*
- *Operating temperature range: -40°C ÷ 110°C*