

Morsetteria orizzontale a carrello passo 5.00mm

Codice Adimpex: **MK752770GO**

MORS. 2EGTR-5.0-10P-14-00AH mHO verde

Serie:327

p/n:2EGTR-5.0-10P-14-00A

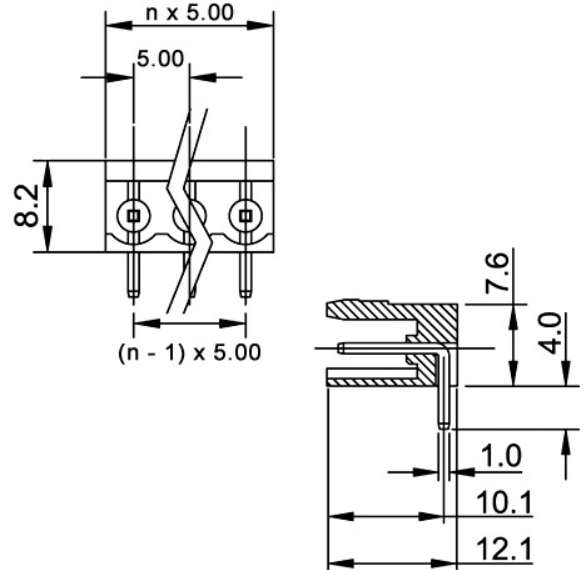
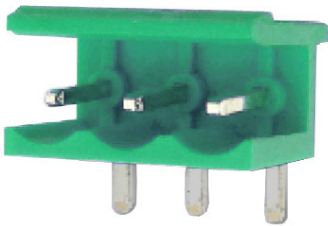

Codice Adimpex	n. poli	portata	AWG	Codice Adimpex	n. poli	portata	AWG
MK752762	2	13 A	12÷24	MK752769	9	13 A	12÷24
MK752763	3	13 A	12÷24	MK752770	10	13 A	12÷24
MK752764	4	13 A	12÷24	MK752771	11	13 A	12÷24
MK752765	5	13 A	12÷24	MK752772	12	13 A	12÷24
MK752766	6	13 A	12÷24	MK752773	13	13 A	12÷24
MK752767	7	13 A	12÷24	MK752774	14	13 A	12÷24
MK752768	8	13 A	12÷24	MK752775	15	13 A	12÷24

Fornibile su richiesta con spallette laterali (tipo chiuso)