

MORSETTIERE ESTRAIBILI

Morsettiera verticale a carrello passo 3.81mm

Codice Adimpex: **MK742940-R**

MORS. 329-101-54 10P/3.81 mVE verde*

Serie:329

p/n:329-101-54 green

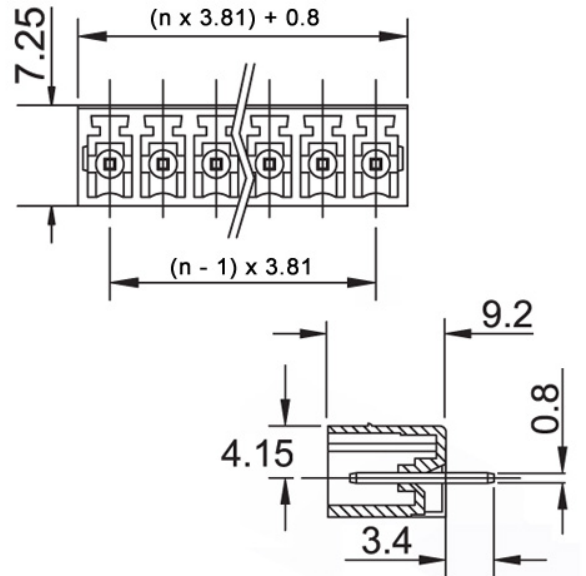
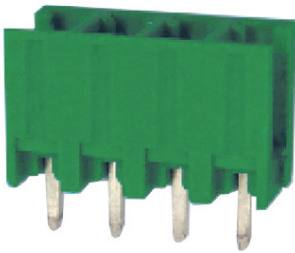

Codice Adimpex	n. poli	portata	AWG
MK742932	2	8 A	16÷28
MK742933	3	8 A	16÷28
MK742934	4	8 A	16÷28
MK742935	5	8 A	16÷28
MK742936	6	8 A	16÷28
MK742937	7	8 A	16÷28
MK742938	8	8 A	16÷28

Codice Adimpex	n. poli	portata	AWG
MK742939	9	8 A	16÷28
MK742940	10	8 A	16÷28
MK742941	11	8 A	16÷28
MK742942	12	8 A	16÷28
MK742943	13	8 A	16÷28
MK742944	14	8 A	16÷28
MK742945	15	8 A	16÷28

CARATTERISTICHE

- Contatti: ottone
- Viti: acciaio zincato e cromato
- Trattamento della parte terminale: stagnato
- Corpo: poliammide PA66 UL94V-0 **verde**
- Tensione: 300V
- Rigidità dielettrica: 1500V AC per 1 minuto
- Temperatura di lavoro: -40°C ÷ 105°C

FEATURES

- *Contacts: brass*
- *Terminal screws: steel galvanized and cromatized*
- *Surface of solder tail: tin plated*
- *Body: polyamide PA66 UL94V-0 **green***
- *Voltage: 300V*
- *Insultaion withstands voltage: 1500V AC for 1 minute*
- *Operating temperature range: -40°C ÷ 105°C*