

Morsettieria a carrello passo 5.00/10.00mm

Codice Adimpex: **MK227503GO**

MORS. GT128-5.0-03P-24-00AH VE ver p.10

Serie:375

p/n:GT128-5.0-03P-24-00A

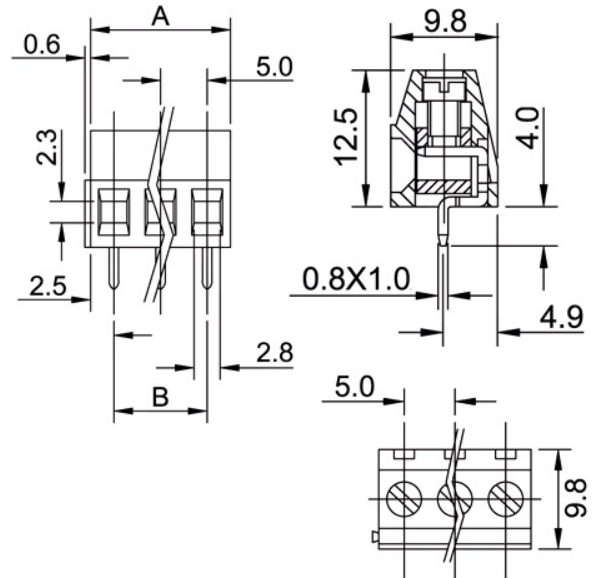

Codice Adimpex	passo	portata	AWG	n. poli	A	B	colore
MK157502	5.00 mm	20 A	14÷22	2	n x 5.00	(n-1) x 5.00	verde
MK157503	5.00 mm	20 A	14÷22	3	n x 5.00	(n-1) x 5.00	verde
MK227502	10.0 mm	20 A	14÷22	2	n x 10.0	(n-1) x 10.0	nero
MK227503	10.0 mm	20 A	14÷22	3	n x 10.0	(n-1) x 10.0	nero