

**Morsetteria a carrello passo 5.00/10.00mm
montaggio a 45°**

Codice Adimpex: **MK153503GO**

MORS. GT330-5.0-03P-12-00AH 45 blu

Serie:335

p/n:GT330-5.0-03P-12-00A

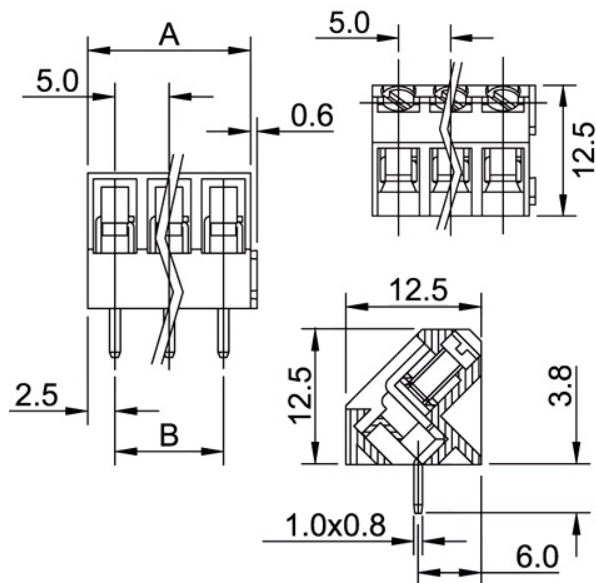

Codice Adimpex	passo	portata	AWG	n. poli	A	B	colore
MK153502	5.00 mm	16 A	14÷22	2	n x 5.00	(n-1) x 5.00	nero
MK153503	5.00 mm	16 A	14÷22	3	n x 5.00	(n-1) x 5.00	nero
MK223502	10.0 mm	16 A	14÷22	2	n x 10.0	(n-1) x 10.0	nero
MK223503	10.0 mm	16 A	14÷22	3	n x 10.0	(n-1) x 10.0	nero