

CONNETTORI D-SUBMINIATURA

Terminale da C.S.

Codice Adimpex: **LU003100-R**

CONN DBD-F15SBTA-L PC-15F-ST

Serie:DBD; MDBD

p/n:DBD-F15SBTA-L

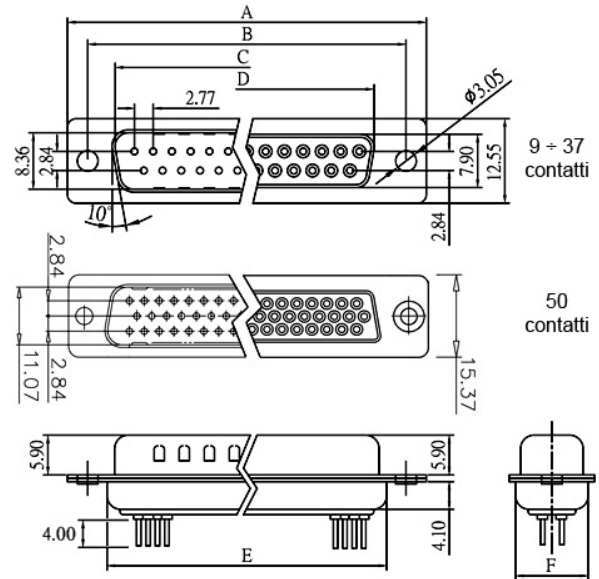
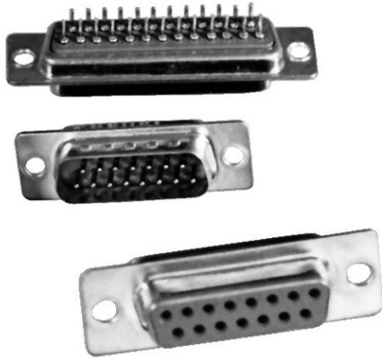

N. di poli	Codice Adimpex TERMINALI STAMPATI		Codice Adimpex TERMINALI TORNITI	
	maschio	femmina	maschio	femmina
9	LU002050	LU003050	LU009605	LU009655
15	LU002100	LU003100	LU009610	LU009660
25	LU002150	LU003150	LU009615	LU009665
37	LU002200	LU003200	LU009620	LU009670
50	LU002250	LU003250	LU009625	LU009675

CARATTERISTICHE

FEATURES

DIMENSIONI

- Corrente: 3 A
- Resistenza di isolamento: 1000MΩ min.
- Resistenza di contatto: 20mΩ max.
- Rigidità dielettrica: 500V AC per 1 minuto
- Gamma di temperatura: -55°C ÷ 105°C
- Isolante: Poliestere, UL 94V-0 Standard PBT
- Contatti: lega di rame
- Terminali stampati o torniti

- Current rate: 3 A
- Insulation resistance: 1000MΩ min.
- Contact resistance: 20mΩ max.
- Dielectric voltage: 500V AC for 1 minute
- Operating temperature: -55°C ÷ 105°C
- Insulator: Polyester, UL 94V-0 Standard PBT
- Contact: copper alloy
- Stamped or machined pins

n. contatti	HD type	A	B	C	D	E	F
09	15	30.81	24.99	16.92	16.33	19.20	10.72
15	26	39.14	33.32	25.50	24.66	27.70	10.72
25	44	53.04	47.04	38.96	38.38	41.10	10.72
37	62	69.32	63.50	55.42	54.84	57.30	10.72
50	78	66.93	61.11	52.81	52.81	52.43	13.56