

CONNETTORI D-SUBMINIATURA

Terminali a saldare

Codice Adimpex: **LU000250-R**

CONN DBS-M50SBTA-L SC 50M-ST

Serie:DBS; MDBS

p/n:DBS-M50SBTA-L

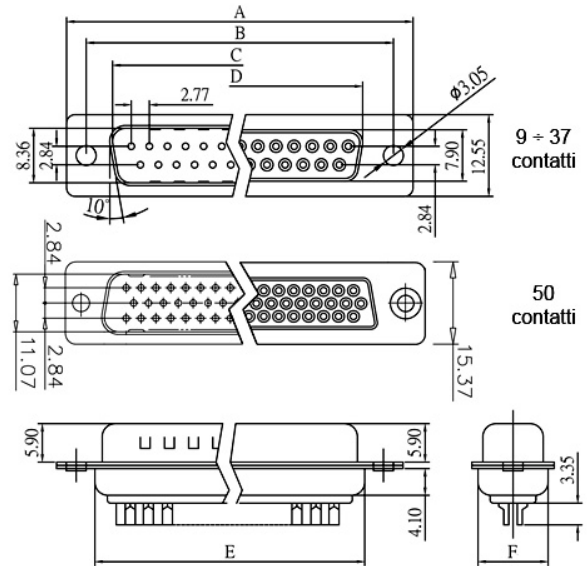

N. di poli	Codice Adimpex TERMINALI STAMPATI		Codice Adimpex TERMINALI TORNITI	
	maschio	femmina	maschio	femmina
9	LU000050	LU001050	LU009505	LU009555
15	LU000100	LU001100	LU009510	LU009560
25	LU000150	LU001150	LU009515	LU009565
37	LU000200	LU001200	LU009520	LU009570
50	LU000250	LU001250	LU009525	LU009575

CARATTERISTICHE

FEATURES

DIMENSIONI

- Corrente: 3 A
- Resistenza di isolamento: 1000MΩ min.
- Resistenza di contatto: 20mΩ max.
- Rigidità dielettrica: 500V AC per 1 minuto
- Gamma di temperatura: -55°C ÷ 105°C
- Isolante: Poliestere, UL 94V-0 Standard PBT
- Contatti: lega di rame
- Terminali stampati o torniti

- *Current rate: 3 A*
- *Insulation resistance: 1000MΩ min.*
- *Contact resistance: 20mΩ max.*
- *Dielectric voltage: 500V AC for 1 minute*
- *Operating temperature: -55°C ÷ 105°C*
- *Insulator: Polyester, UL 94V-0 Standard PBT*
- *Contact: copper alloy*
- *Stamped or machined pins*

n. contatti	HD type	A	B	C	D	E	F
09	15	30.81	24.99	16.92	16.33	19.20	10.72
15	26	39.14	33.32	25.50	24.66	27.70	10.72
25	44	53.04	47.04	38.96	38.38	41.10	10.72
37	62	69.32	63.50	55.42	54.84	57.30	10.72
50	78	66.93	61.11	52.81	52.81	52.43	13.56