

INTERRUTTORI VERTICALI

8.5 x 8.5 x 8.5

Codice Adimpex: **KTK00906-R**

INTER PUSH LTV75-NN11.25-BN NL

Serie: LTV-75

p/n: LTV-75NN9.5-BN

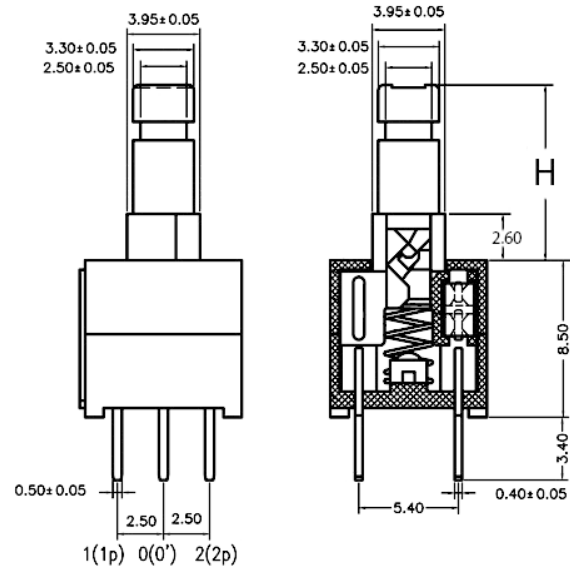
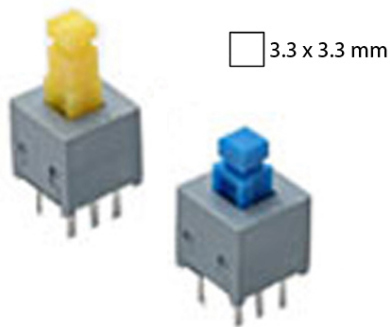

H	Codice Adimpex		circuito	forza di attuazione	cicli
	self lock	non lock			
6.5	KTK00845	KTK00846	2C - 2P	240 ± 50 gr.	20000
9.0	KTK00865	KTK00866	2C - 2P	240 ± 50 gr.	20000
9.5	KTK00885	KTK00886	2C - 2P	240 ± 50 gr.	20000
11.25	KTK00905	KTK00906	2C - 2P	240 ± 50 gr.	20000
12.0	KTK00920	KTK00921	2C - 2P	240 ± 50 gr.	20000
14.5	KTK00945	KTK00946	2C - 2P	240 ± 50 gr.	20000
16.5	KTK00965	KTK00966	2C - 2P	240 ± 50 gr.	20000

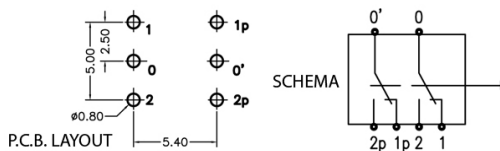

CARATTERISTICHE

- Portata: 0.1 A, 30V DC
- Timing: non-shorting
- Rigidità dielettrica: min. 500V AC per 1 minuto
- Resistenza di contatto: 50 mΩ tip.
- Durata (cicli): 10000
- Resistenza di isolamento: > 500 MΩ

FEATURES

- Rating: 0.1 A, 30V DC
- Timing: non-shorting
- Withstanding voltage: min. 500V AC for 1 minute
- Contact resistance: 50 mΩ typ.
- Life (cycles): 10000
- Insulation resistance: > 500 MΩ