

**INTERRUTTORI TATTILI**

**6 x 6**

Codice Adimpex: **KTH20418KA**

T.S. TSB06153-145 H=14.5 TAPE& REEL 28

Serie: TSB06153

p/n: TSB06153-145(280g)

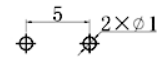
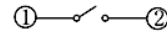
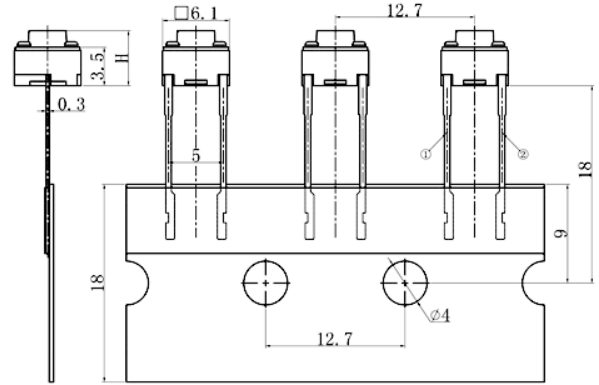

Codice Adimpex		H	corsa
forza di attuazione: 180 ± 50 gf	forza di attuazione: 280 ± 50 gf		
KTH20104	KTH20404	4.3	0.25
KTH20105	KTH20405	5.0	0.25
KTH20107	KTH20407	7.0	0.25
KTH20108	KTH20408	8.0	0.25
KTH20110	KTH20410	9.5	0.25
KTH20112	KTH20412	13	0.25
KTH20118	KTH20418	14.5	0.25

*CARATTERISTICHE*

- Portata: 50mA 12V DC
- Resistenza di contatto: 0.03Ω max.
- Resistenza d'isolamento: 100MΩ min.
- Rigidità dielettrica: 250V AC per 1 minuto
- Gamma di temperatura: -25°C ÷ 70°C

*FEATURES*

- Portata: 50mA 12V DC
- Contact resistance: 0.03Ω max.
- Insulation resistance: 100MΩ min.
- Dielectric withstanding: 250V AC or 1 minute
- Operating temperature: -25°C ÷ 70°C