

INTERRUTTORI TATTILI
6 x 6

 Codice Adimpex: **KTH00512KA**

T.S. TSA06131-130-280-13.0 BU66

Serie: TSA06131

p/n: TSA06131-130(280g)

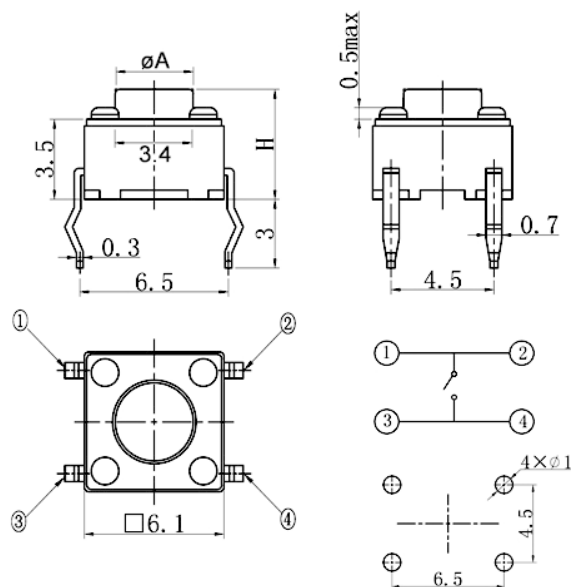

Codice Adimpex		H	A	corsa
forza di attuazione: 180 ± 50 gf	forza di attuazione: 280 ± 50 gf			
KTH00143	KTH00443	4.3	3.4	0.25
KTH00150	KTH00450	5.0	3.4	0.25
KTH00170	KTH00470	7.0	3.2	0.25
KTH00173	KTH00473	7.3	3.2	0.25
KTH00180	KTH00480	8.0	3.2	0.25
KTH00195	KTH00495	9.5	3.1	0.25
KTH00197	KTH00497	9.7	3.1	0.25
KTH00211	KTH00511	12.5	3.1	0.25
KTH00212	KTH00512	13.0	3.2	0.25
KTH00213	KTH00513	13.5	3.0	0.25
KTH00214	KTH00514	14.5	3.1	0.25
KTH00216	KTH00516	16.3	2.8	0.25
KTH00217	KTH00517	17.0	3.2	0.25

Altre altezze fornibili: 4.5, 4.8, 4.9, 5.5, 6.0, 6.4, 6.6, 7.5, 8.5, 8.8, 9.0, 10, 10.3, 10.5, 11, 11.5, 12, 14, 15, 15.5, 15.6, 16, 17.5, 18, 18.5, 19, 19.5, 19.7, 20.2, 21, 21.5, 23, 23.5, 25, 26, 27.2, 28, 29

CARATTERISTICHE

- Portata: 50mA 12V DC
- Resistenza di contatto: 0.03Ω max.
- Resistenza d'isolamento: $100M\Omega$ min.
- Rigidità dielettrica: 250V AC per 1 minuto
- Gamma di temperatura: $-25^{\circ}\text{C} \div 70^{\circ}\text{C}$

FEATURES

- Portata: 50mA 12V DC
- Contact resistance: 0.03Ω max.
- Insulation resistance: $100M\Omega$ min.
- Dielectric withstanding: 250V AC or 1 minute
- Operating temperature: $-25^{\circ}\text{C} \div 70^{\circ}\text{C}$