

CONNETTORI SCHEDA-FILO PASSO 2.54MM

7801 Housing chiuso

Codice Adimpex: **J7801106-R**

CONN. FM p2.54 EX7801HA06P-4 AWG 24

Serie:7801-HA

p/n:780106HA051-4

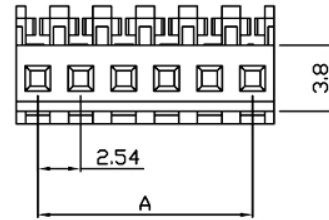
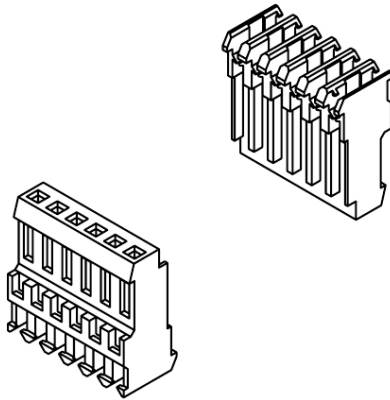

Dimensioni
A = 2.54 x (n - 1)
B = A + 2.54
n = n° posizioni

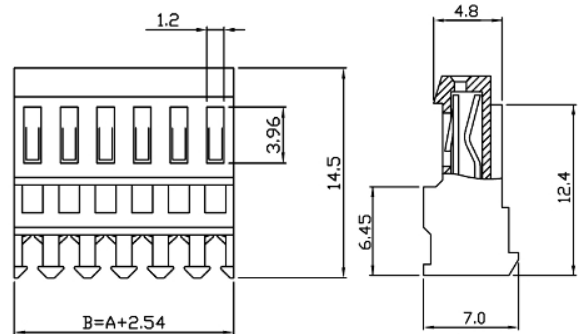

Codice Adimpex	n. posizioni
J7801102	2
J7801103	3
J7801104	4
J7801105	5
J7801106	6
J7801107	7
J7801108	8

Codice Adimpex	n. posizioni
J7801109	9
J7801110	10
J7801111	11
J7801112	12
J7801113	13
J7801114	14
J78011xx	xx (02÷28)

CARATTERISTICHE

FEATURES

ACCESSORI: COVER

- Passo: 2.54mm
- Corrente: 3A AC/DC
- Tensione: 250V AC/DC
- Cavo: 24AWG
(su richiesta 22AWG; 26AWG; 28AWG)
- Corpo: Nylon 66 UL94V-2 colore naturale (HA,HB);
Nylon 66 UL94V-0 colore naturale (WV,WR)
- Terminali maschio: ottone stagnati
- Gamma di temperatura: -25°C ÷ 105°C

- Pitch: 2.54mm
- Current rating: 3A AC/DC
- Voltage rating: 250V AC/DC
- Applicable wires: 24AWG
(on demand 22AWG; 26AWG; 28AWG)
- Housing: Nylon 66 UL94V-2 natural color (HA,HB);
Nylon 66 UL94V-0 natural color (WV,WR)
- Male pins: brass, tin plated
- Operating temperature range: -25°C ÷ 105°C

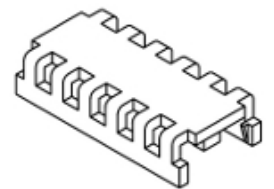

Codice **J78019xx**
posizioni disponibili
02÷28