

Connettori e terminali

HOUSING FEMMINA 5087 9P

CONN. FM p5.08 EX5087HA-09

Codice Adimpex: **J5087109-R**

P/N: **508709HA051**

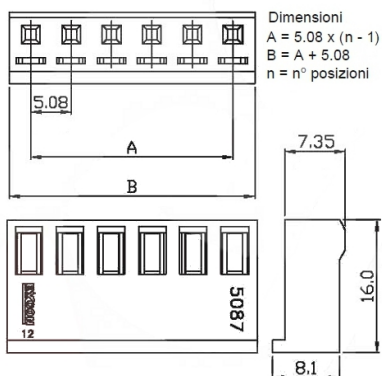
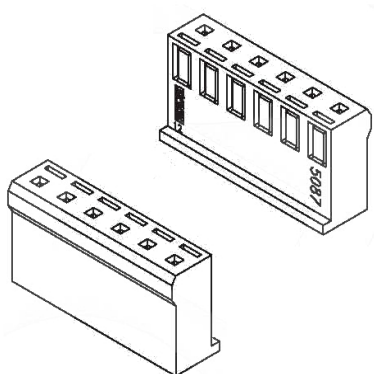

Caratteristiche Tecniche:

Passo:	5.08 mm
Serie:	5087
Pin totali:	9
Tipologia:	Scheda-filo
Montaggio:	Volante/Pannello