

## Connettori e terminali

### HOUSING FEMMINA 5087 4P

CONN. FM p5.08 EX5087HA-04

Codice Adimpex: **J5087104-R**

P/N: **508704HA051**

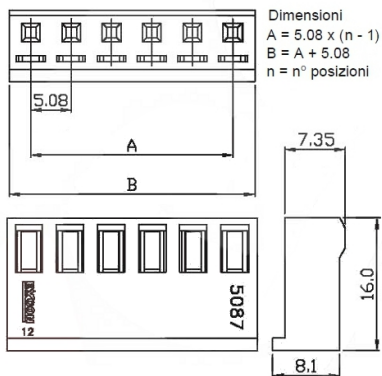
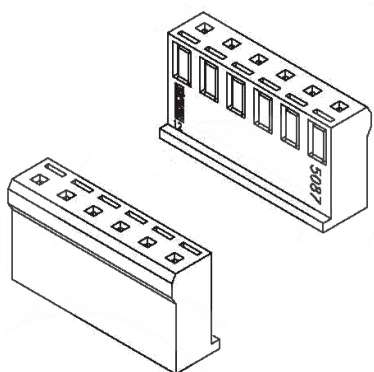

## Caratteristiche Tecniche:

Pin totali:	4
Passo:	5.08 mm
Serie:	5087
Tipologia:	Scheda-filo
Montaggio:	Volante/Pannello