

CONNETTORI SCHEDA-FILO PASSO 5.00MM

5084 Maschio dritto

Codice Adimpex: **J5084403-R**

CONN. MS p5.00 EX5084WV-03P

Serie:5084-WV

p/n:508403WV051

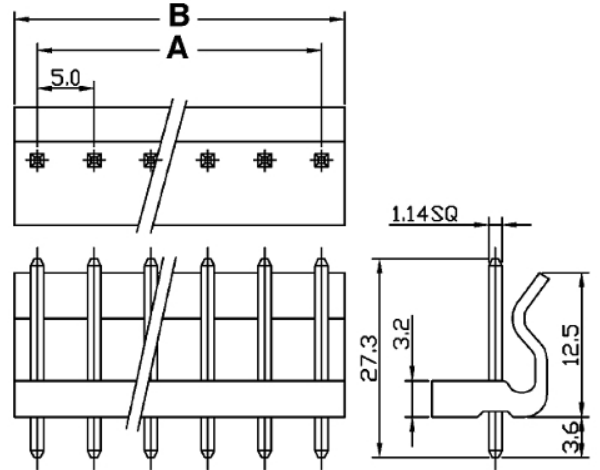
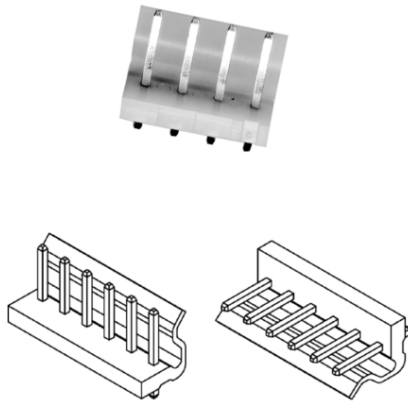

Dimensioni
A = 5.0 x (n - 1)
B = A + 5.0
n = n° contatti

Codice Adimpex	n. posizioni	Codice Adimpex	n. posizioni
J5084402	2	J5084408	8
J5084403	3	J5084409	9
J5084404	4	J5084410	10
J5084405	5	J5084411	11
J5084406	6	J5084412	12
J5084407	7	J50844xx	xx (02÷12)

CARATTERISTICHE

FEATURES

- Passo: 5.00mm
- Corrente: 5A AC/DC
- Tensione: 250V AC/DC
- Cavo: AWG 26÷16
- Corpo: Nylon 66 UL94V-2 colore naturale
- Terminali maschio: ottone pre-stagnati
- Gamma di temperatura: -25°C ÷ 105°C

- Pitch: 5.00mm
- Current rating: 5A AC/DC
- Voltage rating: 250V AC/DC
- Applicable wires: AWG 26÷16
- Housing: Nylon 66 UL94V-2 natural color
- Male pins: brass, tin pre-plated
- Operating temperature range: -25°C ÷ 105°C

