

Connettori e terminali

HOUSING FEMMINA 4201 DOPPIA 18P

CONN. FM p4.2 EX4201HP(9+9)

Codice Adimpex: **J4201218-R**

P/N: **420118HP051 w/clip**

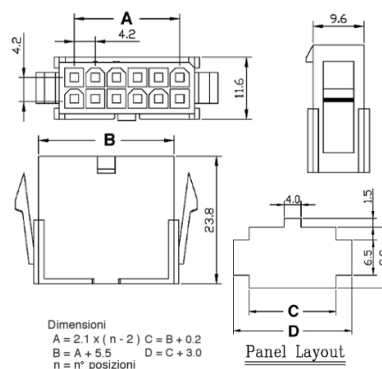
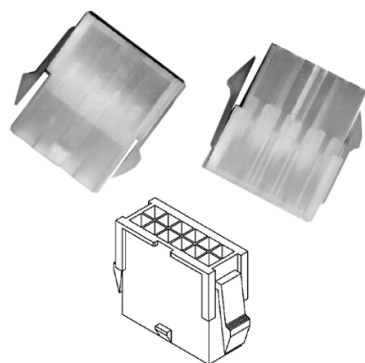

Caratteristiche Tecniche:

Pin totali:	18
Passo:	4.2 mm
Serie:	4201
Tipologia:	Filo-filo / scheda-filo
Montaggio:	Volante/Pannello