

## Connettori e terminali

### HOUSING FEMMINA 4201 DOPPIA 16P

CONN. FM p4.2 EX4201HP(8+8)

Codice Adimpex: **J4201216-R**

P/N: **420116HP051 w/clip**

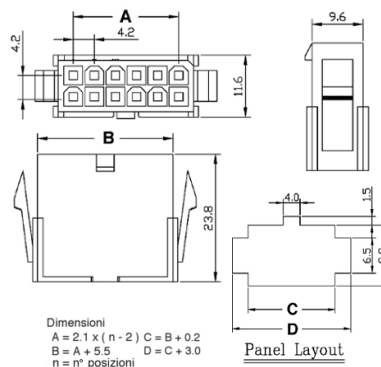
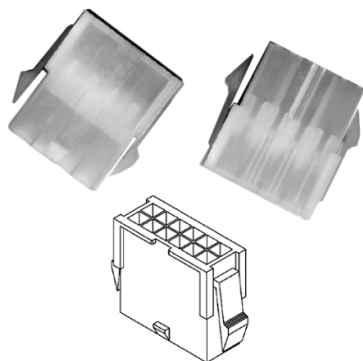

## Caratteristiche Tecniche:

Pin totali:	16
Passo:	4.2 mm
Serie:	4201
Tipologia:	Filo-filo / scheda-filo
Montaggio:	Volante/Pannello