

## Connettori e terminali

### HOUSING FEMMINA 4201 DOPPIA 14P V0

CONN. FM p4.2 EX4201HP(7+7) V0

Codice Adimpex: **J420121499**

P/N: **420114HP001 w/clip V0**

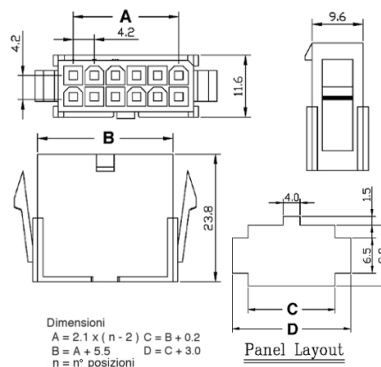
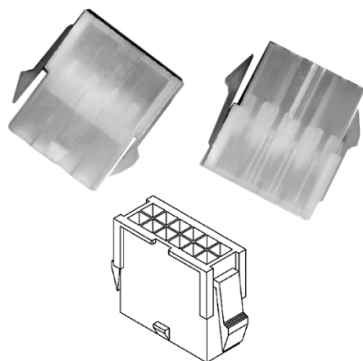

## Caratteristiche Tecniche:

Pin totali:	14
Passo:	4.2 mm
Serie:	4201
Tipologia:	Filo-filo / scheda-filo
Montaggio:	Volante/Pannello