

## Connettori e terminali

### CONNETTORE MASCHIO 3971 DRITTO 8P

CONN. MS p3.96 EX3971WV-08P M.I

Codice Adimpex: **J3971408-R**

P/N: **397108WV558**

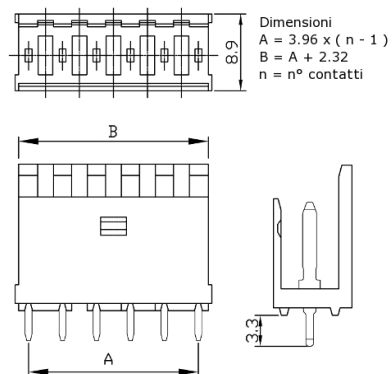
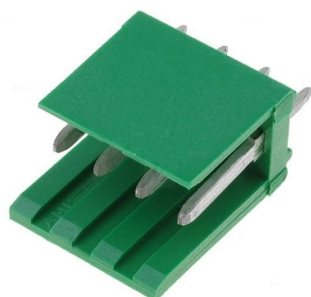

### Caratteristiche Tecniche:

Passo:	3.96 mm
Serie:	3971
Pin totali:	8
Montaggio:	PTH
Tipologia:	Scheda-filo
Orientamento:	Verticale