

Connettori e terminali

HOUSING FEMMINA 3965 9P

CONN. FM p3.96 EX3965HA-09P

Codice Adimpex: **J3965109-R**

P/N: **396509HA051**

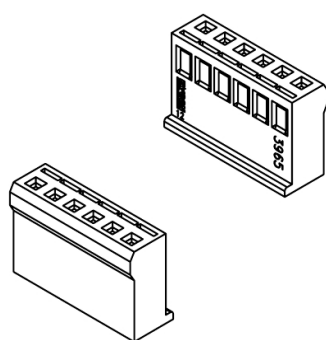

Dimensioni:

A= 3.96 x n-1)

B= A + 5.10

n= numero posizioni

Circuit 1st

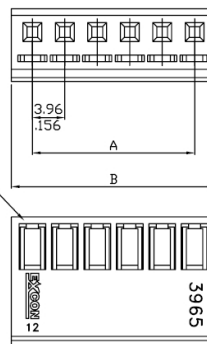

Caratteristiche Tecniche:

Passo:	3.96 mm
Serie:	3965
Pin totali:	9
Tipologia:	Scheda-filo
Montaggio:	Volante/Pannello