

Connettori e terminali

CONNETTORE MASCHIO 3962 DRITTO 4P

CONN. MS p3.96 EX3962WV-04P

Codice Adimpex: **J3962404-R**

P/N: **396204WV001**

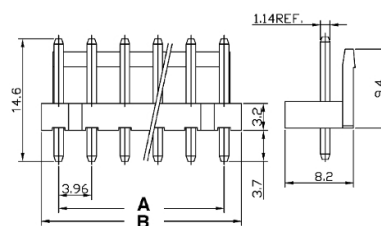
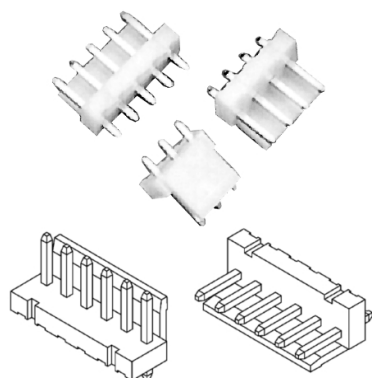

Dimensioni
 $A = 3.96 \times (n - 1)$
 $B = A + 3.96$
 $n = n^{\circ}$ contatti

Caratteristiche Tecniche:

Passo:	3.96 mm
Serie:	3962
Pin totali:	4
Montaggio:	PTH
Tipologia:	Scheda-filo
Orientamento:	Verticale