

## Connettori e terminali

### HOUSING FEMMINA 3962 9P

CONN. FM p3.96 EX3962HA-09P

Codice Adimpex: **J3962109-R**

P/N: **396209HA001**

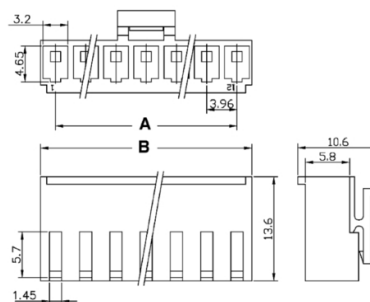
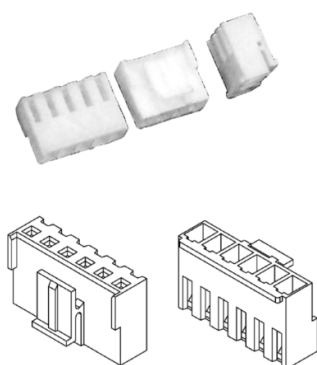

Dimensioni  
 $A = 3.96 \times (n - 1)$   
 $B = A + 3.96$   
 $n = n^{\circ}$  posizioni

## Caratteristiche Tecniche:

Passo:	3.96 mm
Serie:	3962
Pin totali:	9
Tipologia:	Scheda-filo
Montaggio:	Volante/Pannello