

Connettori e terminali

HOUSING FEMMINA 3962 7P

CONN. FM p3.96 EX3962HA-07P

Codice Adimpex: **J3962107-R**

P/N: **396207HA001**

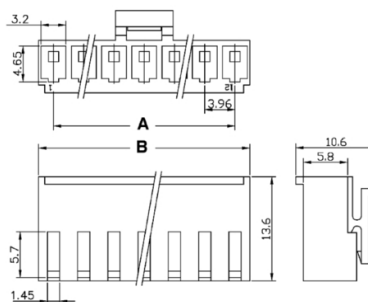
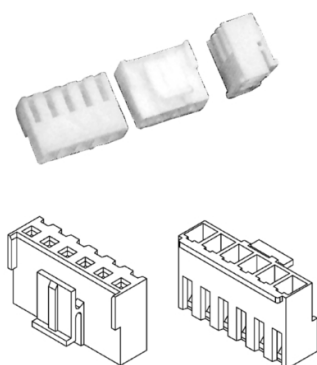

Dimensioni
 $A = 3.96 \times (n - 1)$
 $B = A + 3.96$
 $n = n^{\circ}$ posizioni

Caratteristiche Tecniche:

Passo:	3.96 mm
Serie:	3962
Pin totali:	7
Tipologia:	Scheda-filo
Montaggio:	Volante/Pannello