

Connettori e terminali

HOUSING MASCHIO 3001 10P DOPPIO

CONN. MS p3.00 EX3001HM-(5+5)

Codice Adimpex: **J3001110-R**

P/N: **300110HM003**

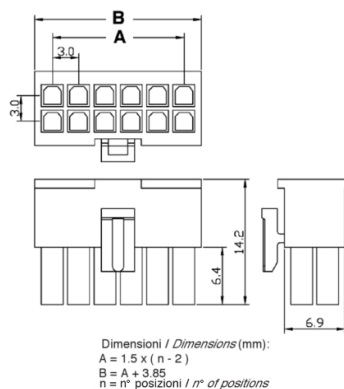
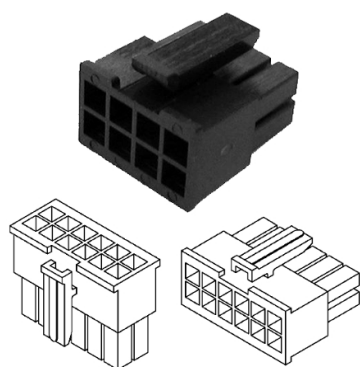

Caratteristiche Tecniche:

Pin totali:	10
Passo:	3 mm
Serie:	3001
Tipologia:	Filo-filo / scheda-filo
Montaggio:	Volante/Pannello