

Connettori e terminali

CONNETTORE MASCHIO 2517 90° 8P

CONN. MS p2.5 EX2517WF-08P

Codice Adimpex: **J2517908-R**

P/N: **251708WF101**

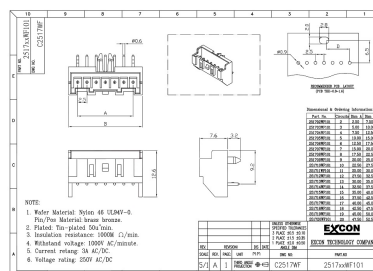
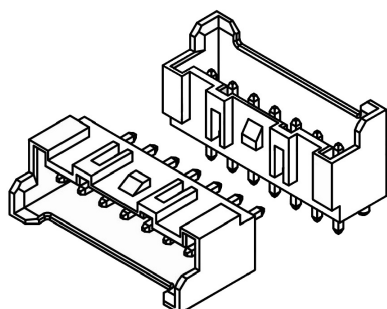

Caratteristiche Tecniche:

Passo:	2.5 mm
Serie:	2517
Pin totali:	8
Orientamento:	90 gradi
Montaggio:	PTH
Tipologia:	Scheda-filo