

Connettori e terminali

CONNETTORE MASCHIO 2517 90° 7P

CONN. MS p2.5 EX2517WF-07P

Codice Adimpex: **J2517907-R**

P/N: **251707WF101**

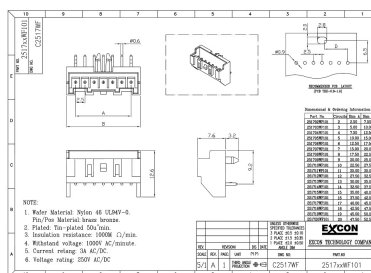
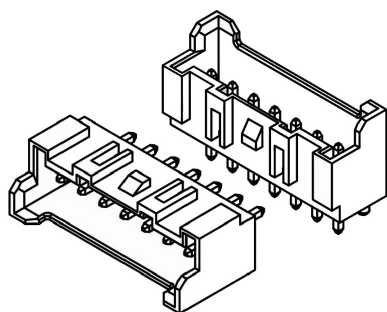

Caratteristiche Tecniche:

Passo:	2.5 mm
Serie:	2517
Pin totali:	7
Orientamento:	90 gradi
Montaggio:	PTH
Tipologia:	Scheda-filo