

## Connettori e terminali

### CONNETTORE MASCHIO 2517 90° 4P

CONN. MS p2.5 EX2517WF-04P

Codice Adimpex: **J2517904-R**

P/N: **251704WF101**

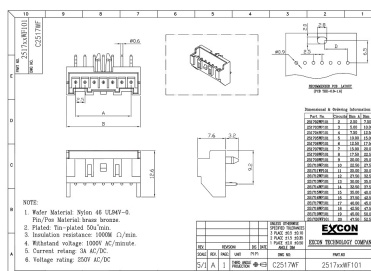
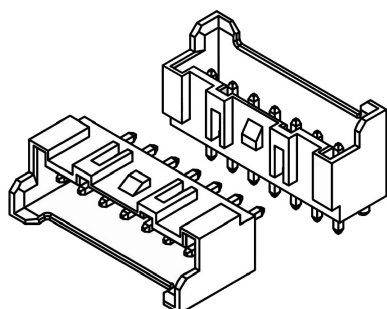

## Caratteristiche Tecniche:

Passo:	2.5 mm
Serie:	2517
Pin totali:	4
Orientamento:	90 gradi
Montaggio:	PTH
Tipologia:	Scheda-filo