

## Connettori e terminali

### HOUSING FEMMINA 2517 10P

CONN. FM p2.5 EX2517HA-10P

Codice Adimpex: **J2517110-R**

P/N: **251710HA001**

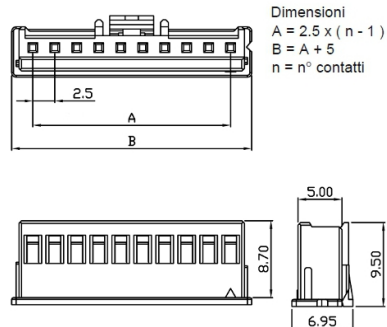
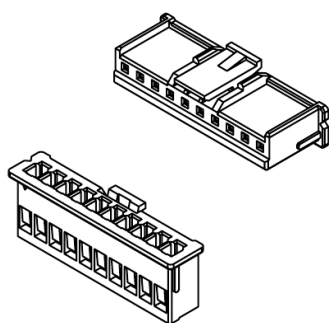

## Caratteristiche Tecniche:

Pin totali:	10
Passo:	2.5 mm
Serie:	2517
Tipologia:	Scheda-filo
Montaggio:	Volante/Pannello