

## Connettori e terminali

### HOUSING FEMMINA 2517 8P

CONN. FM p2.5 EX2517HA-08P

Codice Adimpex: **J2517108-R**

P/N: **251708HA001**

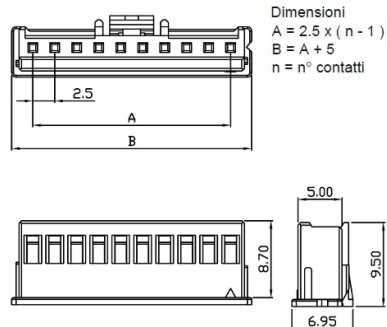
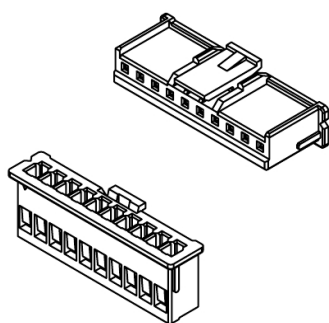

## Caratteristiche Tecniche:

Passo:	2.5 mm
Serie:	2517
Pin totali:	8
Tipologia:	Scheda-filo
Montaggio:	Volante/Pannello