

## Connettori e terminali

### HOUSING FEMMINA 2517 7P

CONN. FM p2.5 EX2517HA-07P

Codice Adimpex: **J2517107-R**

P/N: **251707HA001**

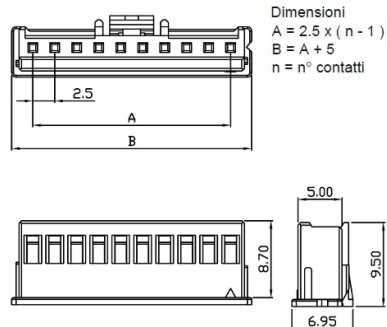
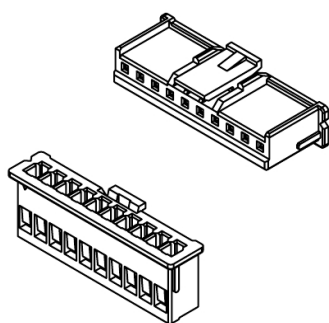

## Caratteristiche Tecniche:

Passo:	2.5 mm
Serie:	2517
Pin totali:	7
Tipologia:	Scheda-filo
Montaggio:	Volante/Pannello