

Connettori e terminali

HOUSING FEMMINA 2517 6P

CONN. FM p2.5 EX2517HA-06P

Codice Adimpex: **J2517106-R**

P/N: **251706HA001**

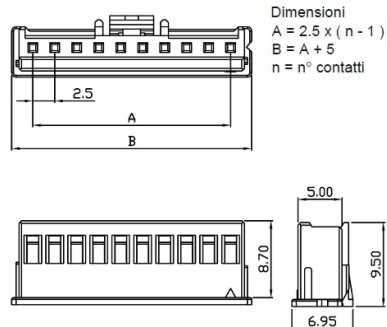
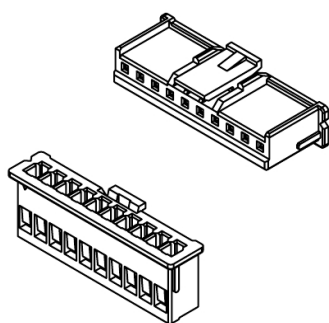

Caratteristiche Tecniche:

Passo:	2.5 mm
Serie:	2517
Pin totali:	6
Tipologia:	Scheda-filo
Montaggio:	Volante/Pannello