

Connettori e terminali

HOUSING FEMMINA 2517 3P

CONN. FM p2.5 EX2517HA-03P

Codice Adimpex: **J2517103-R**

P/N: **251703HA001**

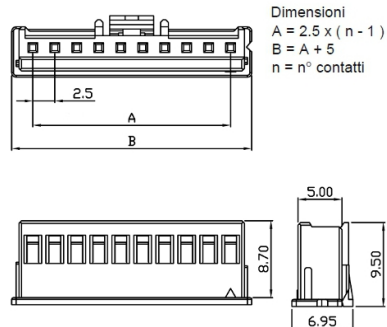
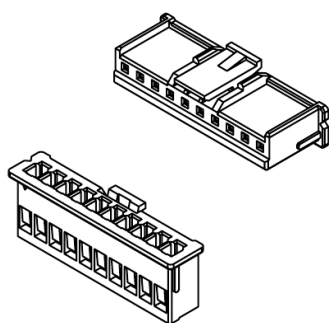

Caratteristiche Tecniche:

Passo:	2.5 mm
Serie:	2517
Pin totali:	3
Tipologia:	Scheda-filo
Montaggio:	Volante/Pannello