

Connettori e terminali

HOUSING FEMMINA 2510 4P

CONN. FM p2.5 EX2510HA-04P

Codice Adimpex: **J2510104-R**

P/N: **251004HA001**

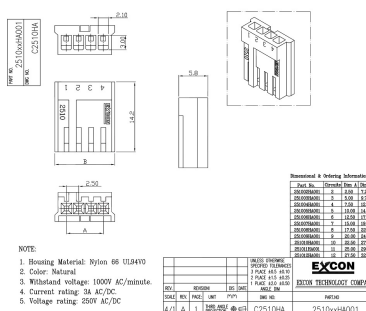
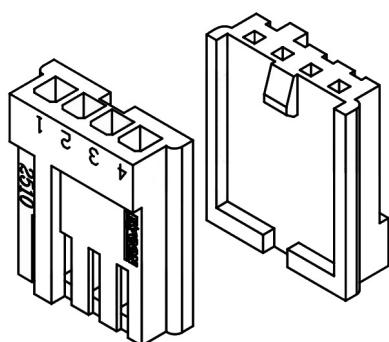

Caratteristiche Tecniche:

Passo:	2.5 mm
Serie:	2510
Pin totali:	4
Tipologia:	Scheda-filo
Montaggio:	Volante/Pannello