

CONNETTORI SCHEDA-FILO PASSO 2.50MM

2504 Maschio 90°

Codice Adimpex: **J2504704-R**

CONN. MSRA p2.5 EX2504WR-04P

Serie:2504-WR

p/n:250404WR001

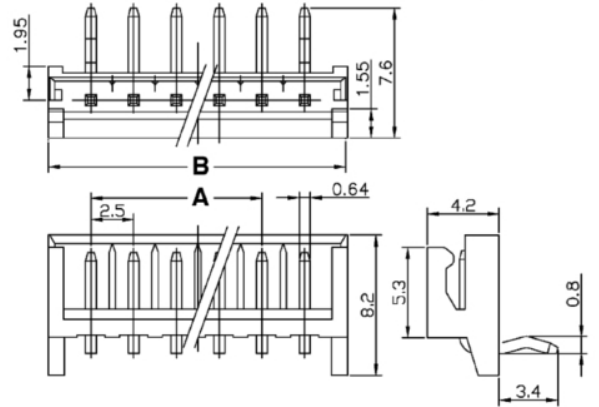
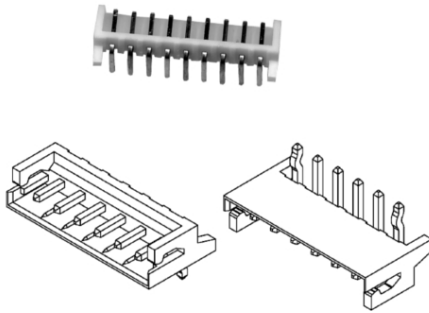

Dimensioni
A = 2.5 x (n - 1)
B = A + 5.0
n = n° contatti

Codice Adimpex	n. posizioni	Codice Adimpex	n. posizioni
J2504702	2	J2504709	9
J2504703	3	J2504710	10
J2504704	4	J2504711	11
J2504705	5	J2504712	12
J2504706	6	J2504713	13
J2504707	7	J2504714	14
J2504708	8	J25047xx	xx (02÷15)

CARATTERISTICHE

- Passo: 2.50mm
- Corrente: 3A AC/DC
- Tensione: 250V AC/DC
- Cavo: AWG 28÷22
- Corpo: Nylon 66 UL94V-0 colore naturale
- Terminali maschio: ottone stagnati
- Gamma di temperatura: -25°C ÷ 105°C

FEATURES

- Pitch: 2.50mm
- Current rating: 3A AC/DC
- Voltage rating: 250V AC/DC
- Applicable wires: AWG 28÷22
- Housing: Nylon 66 UL94V-0 natural color
- Male pins: brass, tin-plated
- Operating temperature range: -25°C ÷ 105°C

