

CONNETTORI SCHEDA-FILO PASSO 2.50MM

2503 Maschio 90°

Codice Adimpex: **J2503704-R**

CONN. MSRA p2.5 EX2503WR-04P

Serie:2503-WR

p/n:250304WR054

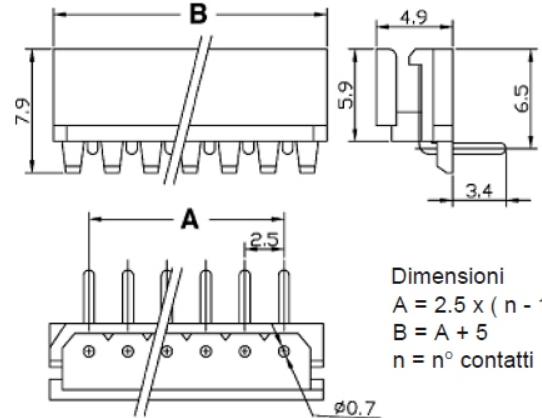
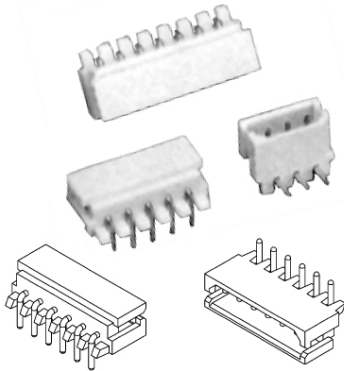

Codice Adimpex	n. posizioni
J2503702	2
J2503703	3
J2503704	4
J2503705	5
J2503706	6
J2503707	7
J2503708	8

Codice Adimpex	n. posizioni
J2503709	9
J2503710	10
J2503711	11
J2503712	12
J2503713	13
J2503714	14
J25037xx	xx (02÷20)

CARATTERISTICHE

- Passo: 2.50mm
- Corrente: 3A AC/DC
- Tensione: 250V AC/DC
- Cavo: AWG 28÷22
- Corpo: Nylon 66 UL94V-2 colore beige
- Terminali maschio: ottone stagnati
- Gamma di temperatura: -40°C ÷ 105°C

FEATURES

- Pitch: 2.50mm
- Current rating: 3A AC/DC
- Voltage rating: 250V AC/DC
- Applicable wires: AWG 28÷22
- Housing: Nylon 66 UL94V-2 beige color
- Male pins: brass, tin plated
- Operating temperature range: -40°C ÷ 105°C