

CONNETTORI SCHEDA-FILO PASSO 2.50MM

2503 Maschio dritto

Codice Adimpex: **J2503410-R**

CONN. MS p2.5 EX2503WV-10P

Serie:2503-WV

p/n:250310WV054

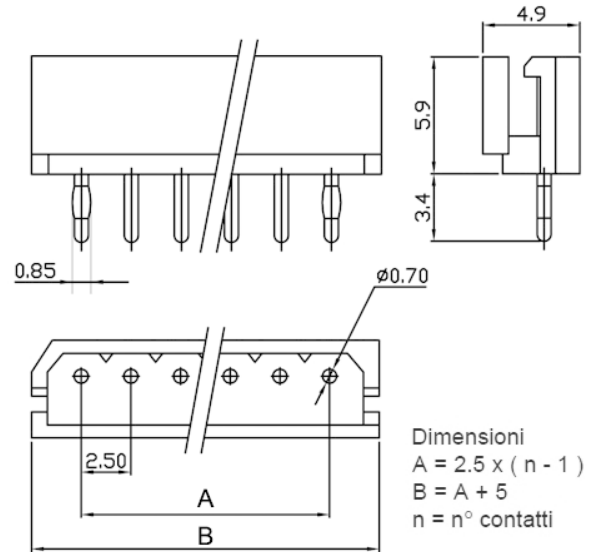
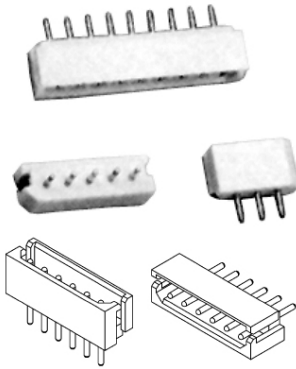

Codice Adimpex	n. posizioni
J2503402	2
J2503403	3
J2503404	4
J2503405	5
J2503406	6
J2503407	7
J2503408	8

Codice Adimpex	n. posizioni
J2503409	9
J2503410	10
J2503411	11
J2503412	12
J2503413	13
J2503414	14
J25034xx	xx (02÷20)

CARATTERISTICHE

- Passo: 2.50mm
- Corrente: 3A AC/DC
- Tensione: 250V AC/DC
- Cavo: AWG 28÷22
- Corpo: Nylon 66 UL94V-2 colore beige
- Terminali maschio: ottone stagnati
- Gamma di temperatura: -40°C ÷ 105°C

FEATURES

- Pitch: 2.50mm
- Current rating: 3A AC/DC
- Voltage rating: 250V AC/DC
- Applicable wires: AWG 28÷22
- Housing: Nylon 66 UL94V-2 beige color
- Male pins: brass, tin plated
- Operating temperature range: -40°C ÷ 105°C

