

CONNETTORI SCHEDE-FILO PASSO 2.50MM

2501 Maschio 90°

Codice Adimpex: **J2501705-R**

CONN. MSRA p2.5 EX2501WR-05P

Serie:2501-WR

p/n:250105WR001

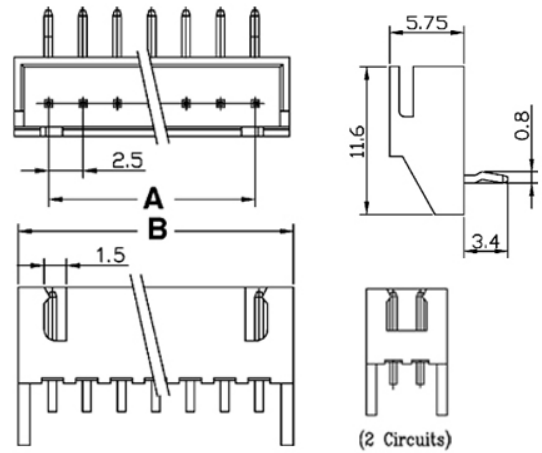
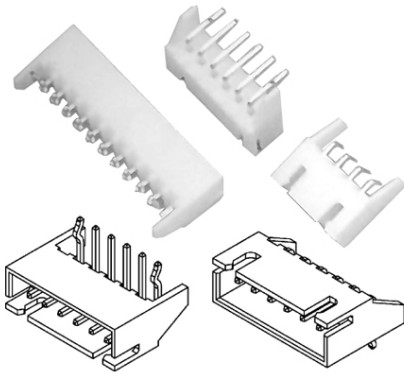

Dimensioni
A = 2.5 x (n - 1)
B = A + 5
n = n° contatti

Codice Adimpex	n. posizioni
J2501702	2
J2501703	3
J2501704	4
J2501705	5
J2501706	6
J2501707	7
J2501708	8

Codice Adimpex	n. posizioni
J2501709	9
J2501710	10
J2501711	11
J2501712	12
J2501713	13
J2501714	14
J25017xx	xx (02÷20)

CARATTERISTICHE

- Passo: 2.5mm
- Corrente: 3A AC/DC
- Tensione: 250V AC/DC
- Cavo: AWG 28÷22
- Corpo: Nylon 66 UL94V-0 colore naturale
- Terminali maschio: ottone stagnati
- Gamma di temperatura: -25°C ÷ 105°C

FEATURES

- Pitch: 2.5mm
- Current rating: 3A AC/DC
- Voltage rating: 250V AC/DC
- Applicable wires: AWG 28÷22
- Housing: Nylon 66 UL94V-0 natural color
- Male pins: brass, tin-plated
- Operating temperature range: -25°C ÷ 105°C

