

## Connettori e terminali

### HOUSING FEMMINA 2501 8P

CONN. FM p2.5 EX2501H-08P

Codice Adimpex: **J2501108-R**

P/N: **250108HA001**

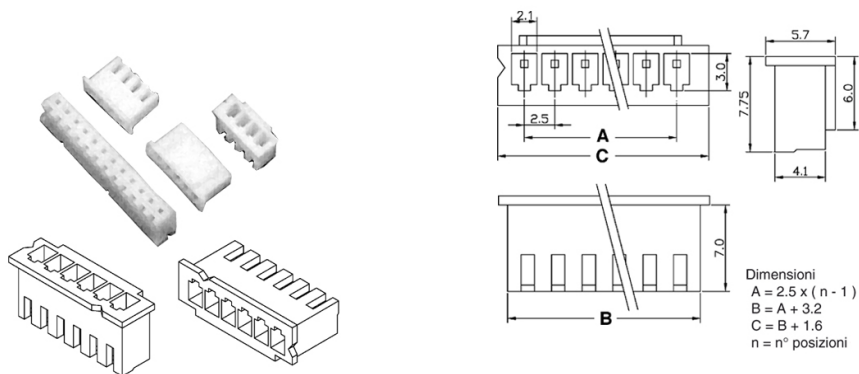

## Caratteristiche Tecniche:

Passo:	2.5 mm
Serie:	2501
Pin totali:	8
Tipologia:	Scheda-filo
Montaggio:	Volante/Pannello