

CONNETTORI SCHEDA-FILO PASSO 2.00MM

2001 Maschio 90°

Codice Adimpex: **J2001710-R**

CONN. MSRA p2.0 EX2001WR-10P

Serie:2001-WR

p/n:200110WR001

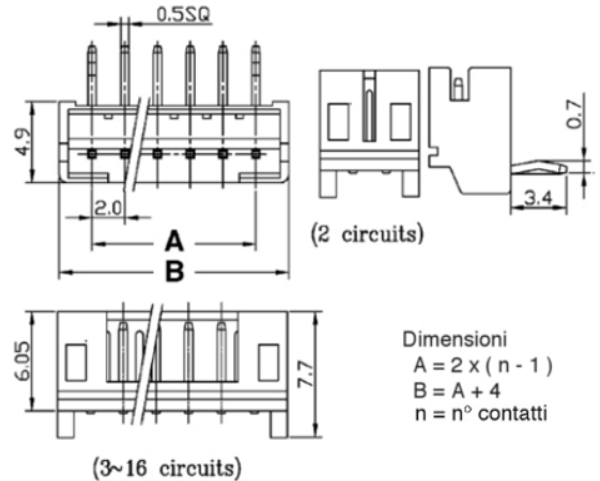
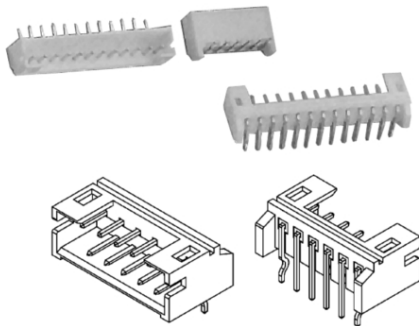

Codice Adimpex	n. posizioni
J2001702	2
J2001703	3
J2001704	4
J2001705	5
J2001706	6
J2001707	7
J2001708	8

Codice Adimpex	n. posizioni
J2001709	9
J2001710	10
J2001711	11
J2001712	12
J2001713	13
J2001714	14
J20017xx	xx (02÷16)

CARATTERISTICHE

- Passo: 2.00mm
- Corrente: 3A AC/DC
- Tensione: 250V AC/DC
- Cavo: AWG 30÷22
- Corpo: Nylon 66 UL94V-0 colore naturale(HA,WV,WR); Nylon 6T UL94V-0 colore naturale (WD,WE)
- Terminali maschio: ottone stagnati
- Gamma di temperatura: -25°C ÷ 105°C

FEATURES

- Pitch: 2.00mm
- Current rating: 3A AC/DC
- Voltage rating: 250V AC/DC
- Applicable wires: AWG 30÷22
- Housing: Nylon 66 UL94V-0 natural color (HA,WV,WR); Nylon 6T UL94V-0 natural color (WD,WE)
- Male pins: brass, tin-plated
- Operating temperature range: -25°C ÷ 105°C

