

CONNETTORI SCHEDE-FILO PASSO 2.00MM

2001 Maschio dritto SMD

Codice Adimpex: **J2001503-R**

CONN.MS SMD P.2.0 EX2001WD-03P*

Serie:2001-WD

p/n:200103WD101 TUBE

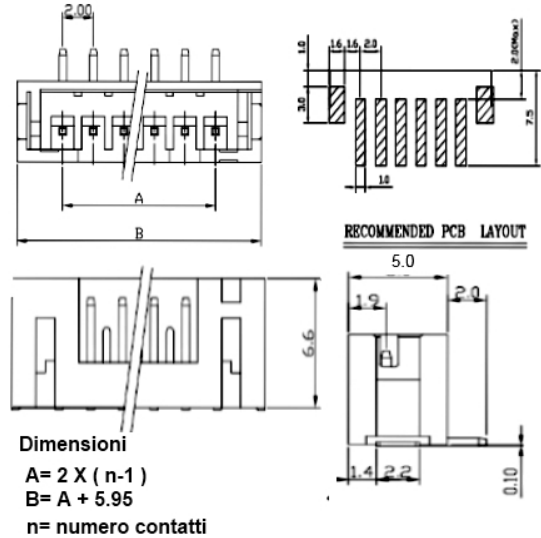
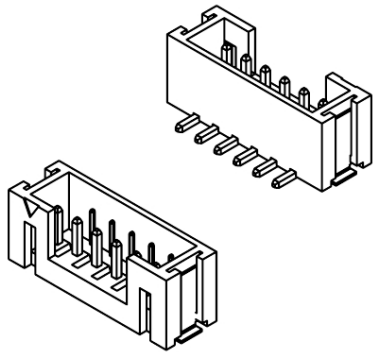

Codice Adimpex	n. posizioni	Codice Adimpex	n. posizioni
J2001502	2	J2001509	9
J2001503	3	J2001510	10
J2001504	4	J2001511	11
J2001505	5	J2001512	12
J2001506	6	J2001513	13
J2001507	7	J2001514	14
J2001508	8	J20015xx	xx (02÷16)

Confezionato in tubo.

CARATTERISTICHE

FEATURES

- Passo: 2.00mm
- Corrente: 3A AC/DC
- Tensione: 250V AC/DC
- Cavo: AWG 30÷22
- Corpo: Nylon 66 UL94V-0 colore naturale(HA,WV,WR); Nylon 6T UL94V-0 colore naturale (WD,WE)
- Terminali maschio: ottone stagnati
- Gamma di temperatura: -25°C ÷ 105°C

- Pitch: 2.00mm
- Current rating: 3A AC/DC
- Voltage rating: 250V AC/DC
- Applicable wires: AWG 30÷22
- Housing: Nylon 66 UL94V-0 natural color (HA,WV,WR); Nylon 6T UL94V-0 natural color (WD,WE)
- Male pins: brass, tin-plated
- Operating temperature range: -25°C ÷ 105°C

