

CONNETTORI SCHEDE-FILO PASSO 2.00MM

2001 Maschio dritto

Codice Adimpex: **J2001407-R**

CONN. MS p2.0 EX2001WV-07P

Serie:2001-WV

p/n:200107WV001

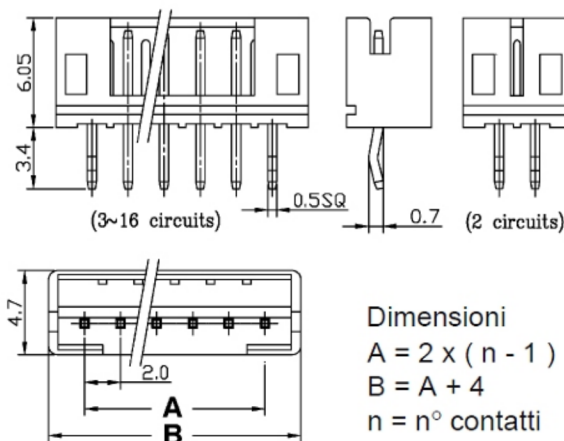
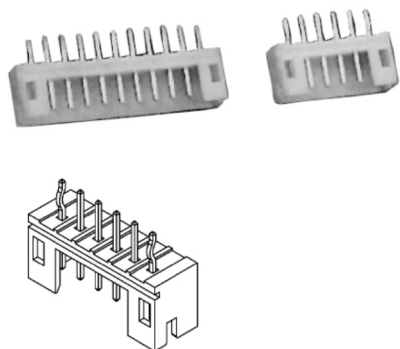

Codice Adimpex	n. posizioni	Codice Adimpex	n. posizioni
J2001402	2	J2001409	9
J2001403	3	J2001410	10
J2001404	4	J2001411	11
J2001405	5	J2001412	12
J2001406	6	J2001413	13
J2001407	7	J2001414	14
J2001408	8	J20014xx	xx (02÷16)

CARATTERISTICHE

- Passo: 2.00mm
- Corrente: 3A AC/DC
- Tensione: 250V AC/DC
- Cavo: AWG 30÷22
- Corpo: Nylon 66 UL94V-0 colore naturale(HA,WV,WR); Nylon 6T UL94V-0 colore naturale (WD,WE)
- Terminali maschio: ottone stagnati
- Gamma di temperatura: -25°C ÷ 105°C

FEATURES

- Pitch: 2.00mm
- Current rating: 3A AC/DC
- Voltage rating: 250V AC/DC
- Applicable wires: AWG 30÷22
- Housing: Nylon 66 UL94V-0 natural color (HA,WV,WR); Nylon 6T UL94V-0 natural color (WD,WE)
- Male pins: brass, tin-plated
- Operating temperature range: -25°C ÷ 105°C

