

CONNETTORI SCHEDA-FILO PASSO 1.50MM

1501 Maschio dritto

Codice Adimpex: **J1501410-R**

CONN. MS p1.5 EX1501WV-10P

Serie:1501-WV

p/n:150110WV004

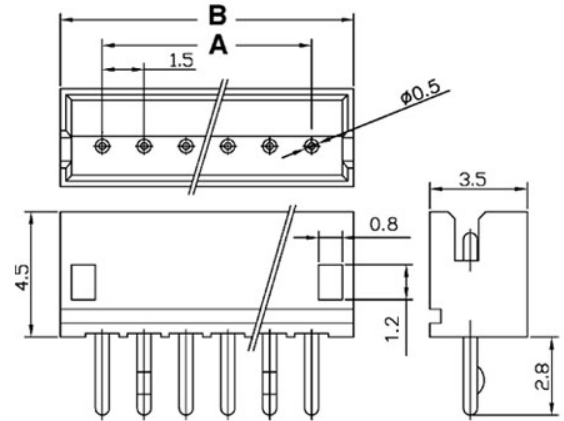
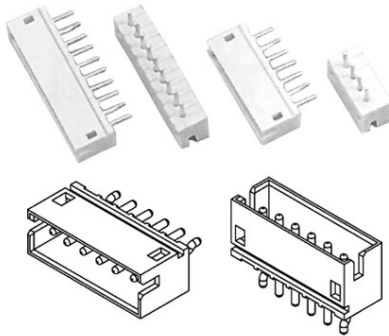

Dimensioni / Dimensions (mm):

$$A = 1.5 \times (n - 1)$$

$$B = A + 3.0$$

$$n = n^{\circ} \text{ posizioni} / n^{\circ} \text{ of positions}$$

Codice Adimpex	n. posizioni
J1501402	2
J1501403	3
J1501404	4
J1501405	5
J1501406	6
J1501407	7
J1501408	8

Codice Adimpex	n. posizioni
J1501409	9
J1501410	10
J1501411	11
J1501412	12
J1501413	13
J1501414	14
J15014xx	xx (02÷15)

CARATTERISTICHE

- Passo: 1.50mm
- Corrente: 1A AC/DC
- Tensione: 100V AC/DC
- Cavo: AWG 30÷26
- Corpo: Nylon 66 UL94V-0 colore naturale (HA);
Nylon 66 UL94V-0 colore beige (WV,WR);
Nylon 6T UL94V-0 colore naturale (WD,WE)
- Terminali maschio: ottone stagnati
- Gamma di temperatura: -25°C ÷ 105°C

FEATURES

- Pitch: 1.50mm
- Current rating: 1A AC/DC
- Voltage rating: 100V AC/DC
- Applicable wires: AWG 30÷26
- Housing: Nylon 66 UL94V-0 natural color (HA);
Nylon 66 UL94V-0 beige color (WV,WR);
Nylon 6T UL94V-0 natural color (WD,WE)
- Male pins: brass, tin plated
- Operating temperature range: -25°C ÷ 105°C