

CONNETTORI SCHEDE-FILO PASSO 1.25MM

1251 Maschio dritto

Codice Adimpex: **J1251411-R**

CONN. MS p1.25 EX1251WV-11P

Serie:1251-WV

p/n:125111WV101

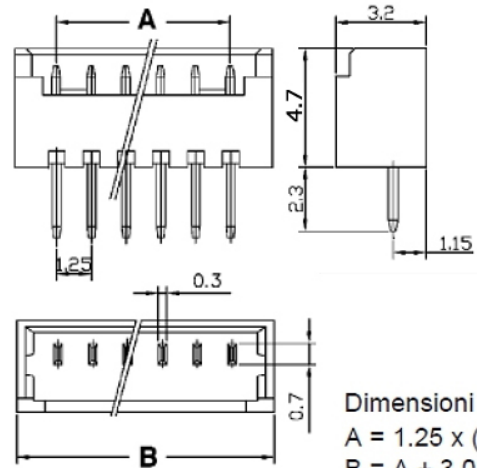
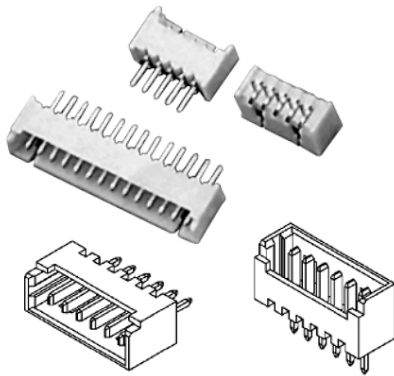

Dimensioni
A = 1.25 x (n - 1)
B = A + 3.0
n = n° posizioni

Codice Adimpex	n. posizioni
J1251402	2
J1251403	3
J1251404	4
J1251405	5
J1251406	6
J1251407	7
J1251408	8

Codice Adimpex	n. posizioni
J1251409	9
J1251410	10
J1251411	11
J1251412	12
J1251413	13
J1251414	14
J12514xx	xx (02÷15)

CARATTERISTICHE

- Passo: 1.25mm
- Corrente: 1A AC/DC
- Tensione: 100V AC/DC
- Cavo: AWG 30÷26
- Corpo: PBT UL94V-0 colore naturale (HA); Nylon 6T UL94V-0 colore naturale (WV,WR,WD,WE)
- Terminali maschio: ottone stagnati
- Gamma di temperatura: -40°C ÷ 105°C

FEATURES

- Pitch: 1.25mm
- Current rating: 1A AC/DC
- Voltage rating: 100V AC/DC
- Applicable wires: AWG 30÷26
- Housing: PBT UL94V-0 natural color (HA); Nylon 6T UL94V-0 natural color (WV,WR,WD,WE)
- Male pins: brass, tin plated
- Operating temperature range: -40°C ÷ 105°C

