

Spine e prese DIN e MINI

SPINA DIN FEMMINA 7P

SPINA DIN (7)-7P/270 DSP-306-7P

Codice Adimpex: **GQ220718ID**

P/N: **DSP-306-7P**

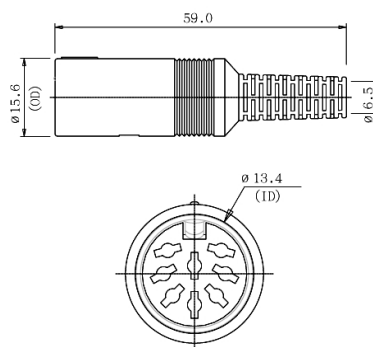

Caratteristiche Tecniche:

Pin totali:	7
Gamma:	DIN
Tipologia:	Spina FM
Montaggio:	Volante