

Spine e prese DIN e MINI

SPINA DIN FEMMINA 5P

SPINA DIN (5)-5P/240 DSP-306-5P

Codice Adimpex: **GQ220524ID**

P/N: **DSP-306-5P**

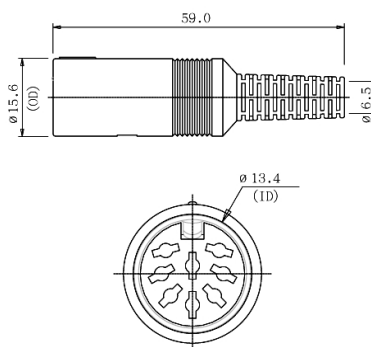

Caratteristiche Tecniche:

Pin totali:	5
Gamma:	DIN
Tipologia:	Spina FM
Montaggio:	Volante