

Spine e prese DIN e MINI

PRESA MINI DIN 8P

PRESA DIN MINIATURA SCN570-S8

Codice Adimpex: **GPQ00508-R**

P/N: **SCN570S8NS0B000G**

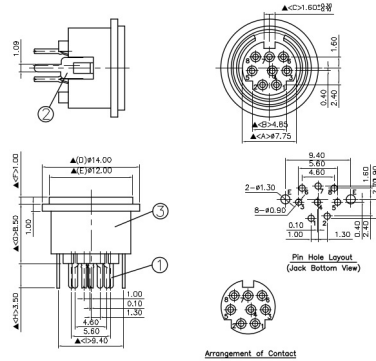

Caratteristiche Tecniche:

Pin totali:	8
Gamma:	MINI DIN
Tipologia:	Preso FM
Montaggio:	PTH Verticale